

BenQ Board Master

# Explore new possibilities

Unleash your teaching potential with the best tools for today's classrooms.

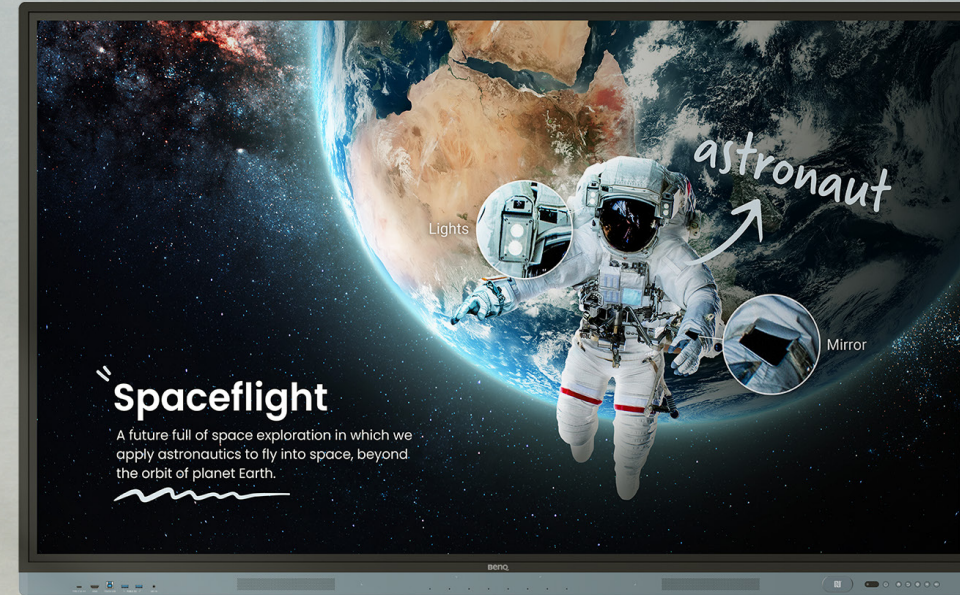

**BenQ**  
Education

BenQ Board Master  
RM6504 / RM7504 / RM8604



EDLA



ClassroomCare®



NFC

# Google-powered lessons

## Intuitive teaching with Google

Harness the power of BenQ hardware and Google services for education with the EDLA-certified BenQ Board Master RM04.



### Easy app access

Enhance your lessons with interactive educational apps from Google Play.



### Google essentials

The RM04 comes with Google Core Services such as Google Drive and Meet.



### Collaboration tools

Fully utilize Google Docs, Sheets, and Slides on a large touchscreen display.

# Google-powered lessons

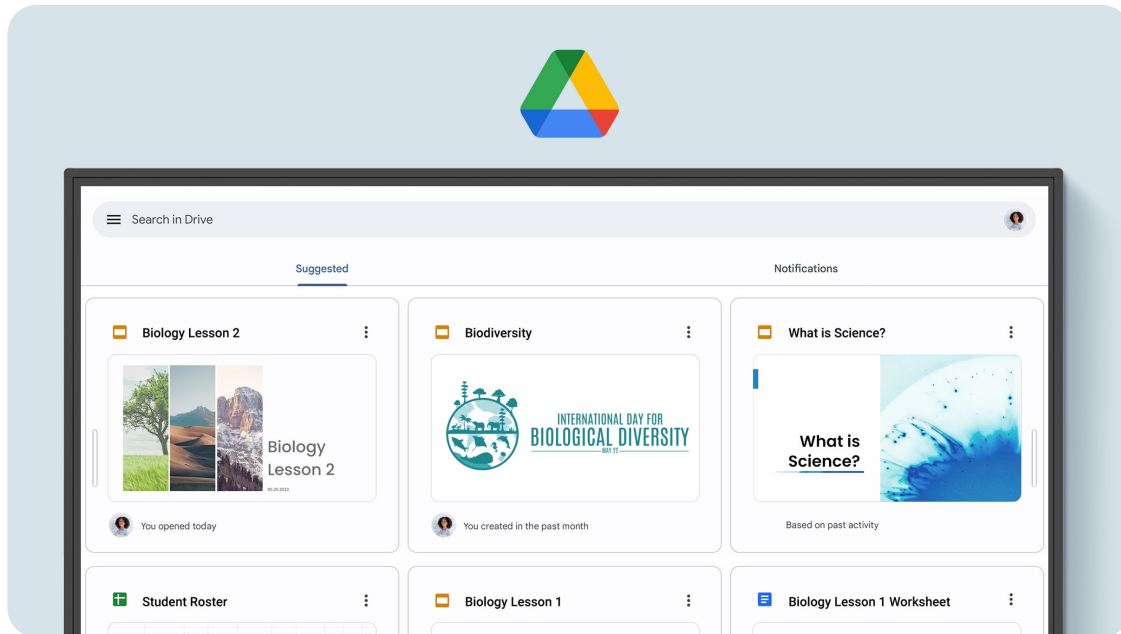

## Convenient file access

Open files from your Google Drive to teach with material you've prepared beforehand, and save them right back onto the cloud so you can always have access to the latest files.



## Enhanced security

Google's security features on your RM04 prevent data leaks, phishing, malware, and data loss.



# Google-powered lessons

## Personalized screen

You can change the layout of your Home screen by moving apps, or dragging them to a new page.





# Google-powered lessons



## Google Search

Look up information and access lesson materials in an instant without having to open the browser.

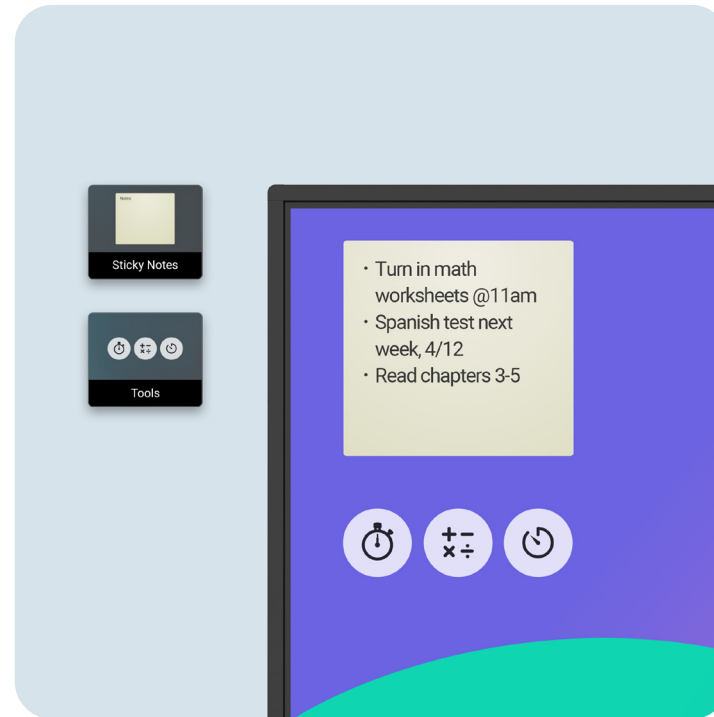

## Widgets

Add widgets—like sticky notes and the calendar—to display the information that matters to you and your students.



## Voice assistant

Let your voice guide your lessons using Google Assistant via the RM04 remote control.

# Google-powered lessons

## AI tools for more inclusive lessons



### Text-to-speech

Hear text as it is displayed or written on screen.



### Multilingual translation

Translate text in numerous languages for more context-rich lessons.

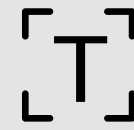

### OCR

Easily edit text from photos and scanned pages.

## Whiteboard without limits

Enhance your lessons using EZWrite, a powerful whiteboard that's packed with classroom tools you can use for more engaging face-to-face or hybrid classes.





# Whiteboard without limits

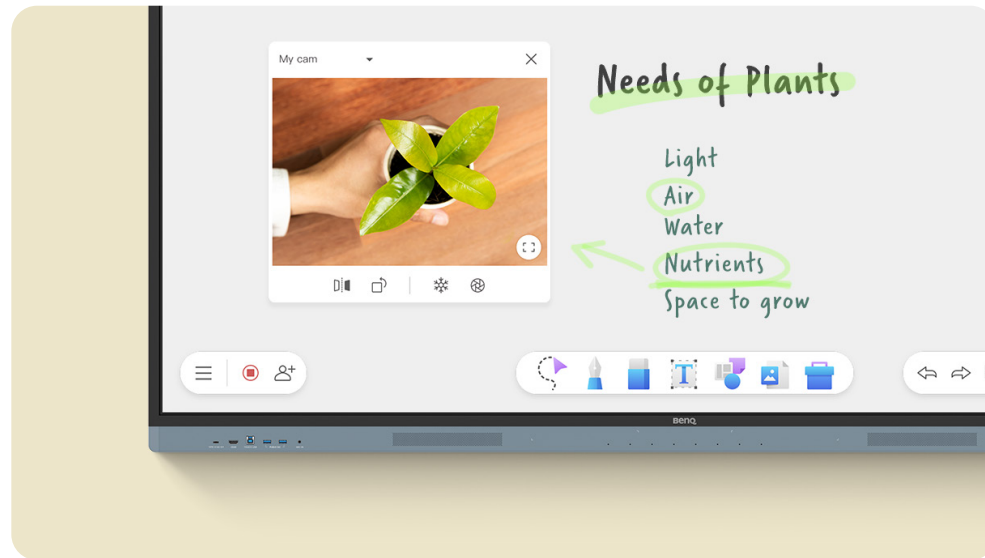

## More than just a whiteboard

EZWrite 6 lets you do a lot more than just write, draw, and add text. Use the expandable canvas, split the screen for competitions, insert templates, use math tools, or show a live camera feed.

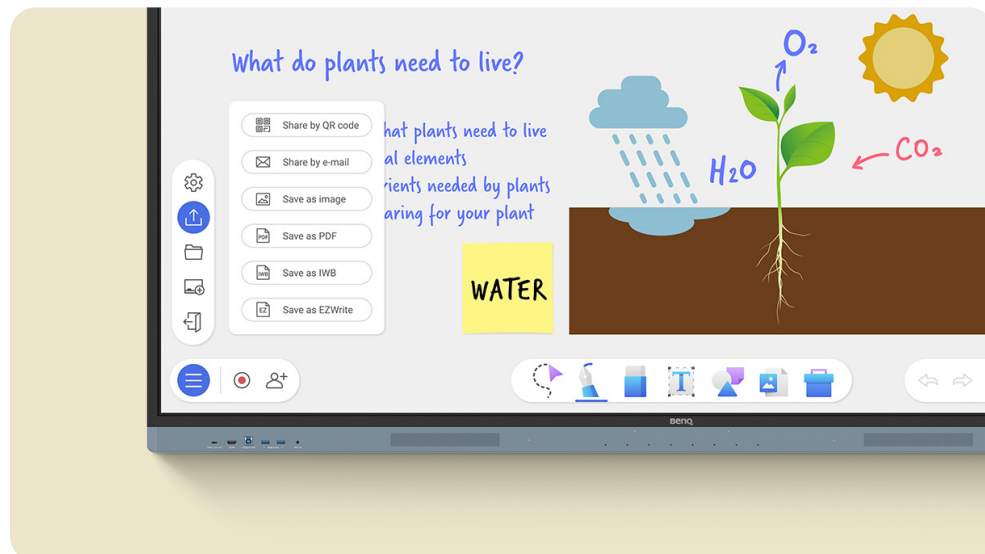

## Import and export files

Open PowerPoint, Word, Excel, and PDF files to teach with and make notes on during class. When you're done, save the lesson as an editable whiteboard file to pick up where you left off or as a PDF for students to review at home.

# Whiteboard without limits

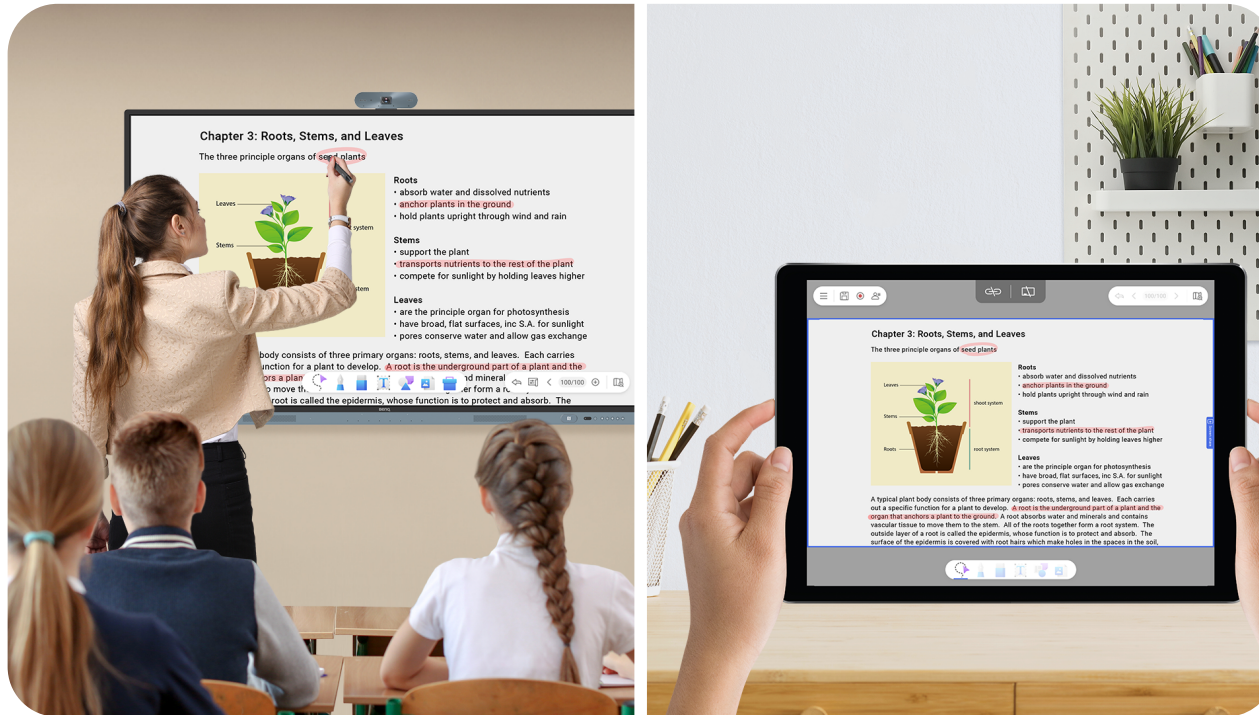

## Extend your classroom

Cloud whiteboarding lets students join the session from their seats or even from home. Remote students can use the whiteboard as if they were right on the display.

# A smarter teaching environment

Everything you need to enhance the way you teach  
is already on the RM04.





# A smarter teaching environment

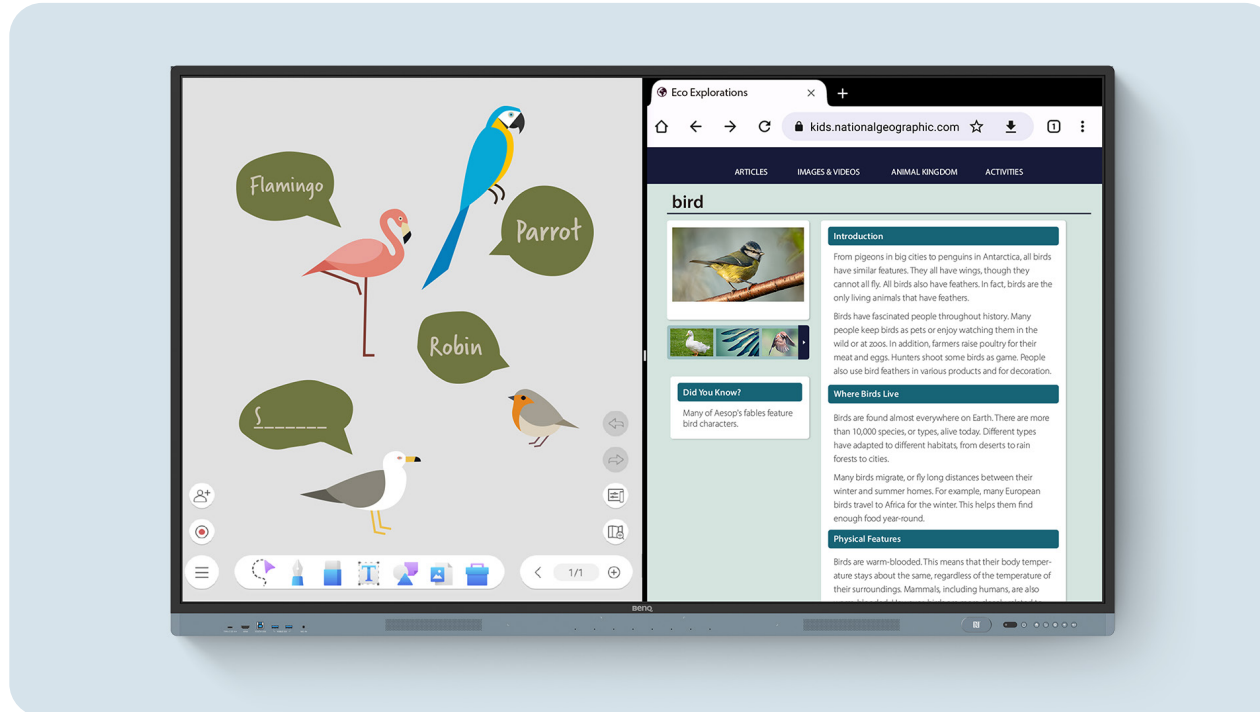

## Maximize teaching efficiency

Whiteboard while searching the web on the same screen. Activate the split-screen mode and have two apps open side by side for more dynamic lessons.



## Log in your way

The RM04 offers efficient and secure ways to log in, load your personal settings, and access your cloud storage. You can either tap your NFC card or just scan the board's QR code with your phone.

\*Available by the end of Q4.

# A smarter teaching environment

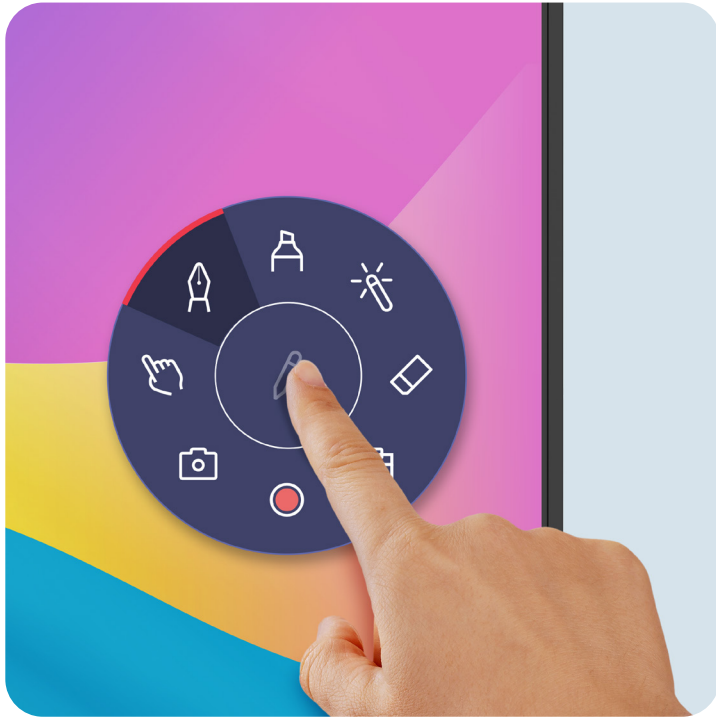

## Tools within reach

Pull up the Floating Tool to annotate, take screenshots, or even record videos while you're using apps, browsing files, or scrolling through sites on the board.

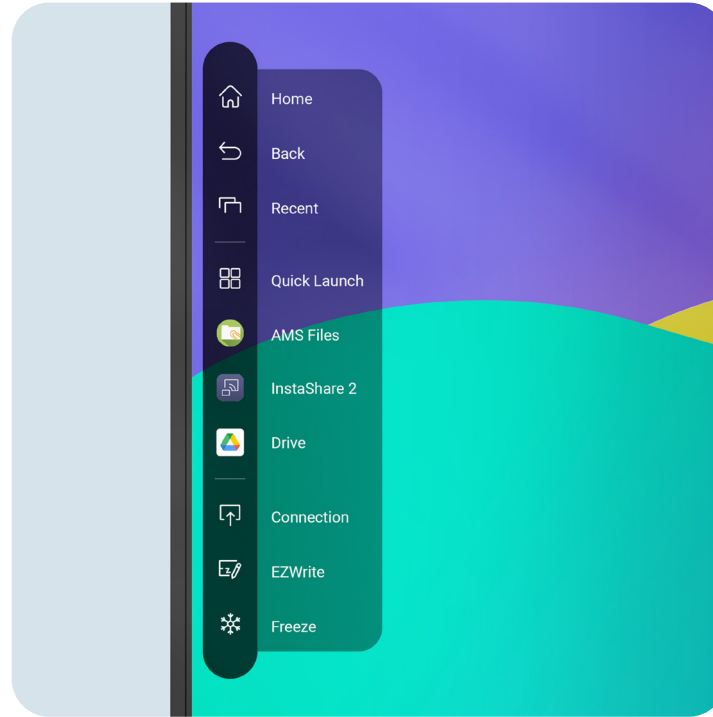

## Quick access every time

Tap the sidebar to quickly switch input sources, go back to the Home screen, or get a menu of your most-used apps.



## Front-facing ports

The multiple front ports include a full-functioned USB-C port that provides 65W of charging and allows you to extend your laptop screen and gain touchback controls.

# A smarter teaching environment



## Stream and record classes with AI

Combine the BenQ Board with the DV01K smart 4K UHD camera for high-quality video streaming and recording. Ensure clear and dynamic audiovisuals with the camera's built-in AI features including auto framing, face and voice tracking, and active noise cancellation.



AI-powered  
auto framing



AI-powered  
speaker tracking



Active noise  
cancellation



# A smarter teaching environment



## All-around sound

The two 20-Watt front-facing speakers provide room-filling sound for any class. Together with the 8-microphone array, they ensure that everyone can hear and be heard during calls or audiovisual lessons.

# A smarter teaching environment

## Smooth and intuitive writing

The BenQ Board Master allows multiple students to interact intuitively with the display at the same time for group work and other classroom activities.

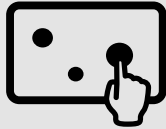

### 40 touch points

The RM04 allows up to 40 touch points to let everyone interact on the display at the same time.



### Natural writing

Zero gap between the glass and panel makes writing feel as smooth as writing on paper.



### High Precision IR

High Precision IR touch provides the most accurate writing experience of any BenQ Board.

# Seamless idea sharing

Wirelessly share content onto the RM04 from anywhere in the room. Cast lesson materials from your laptop or let multiple students share their screens with InstaShare 2.





# An easier way to share



Control devices from the board

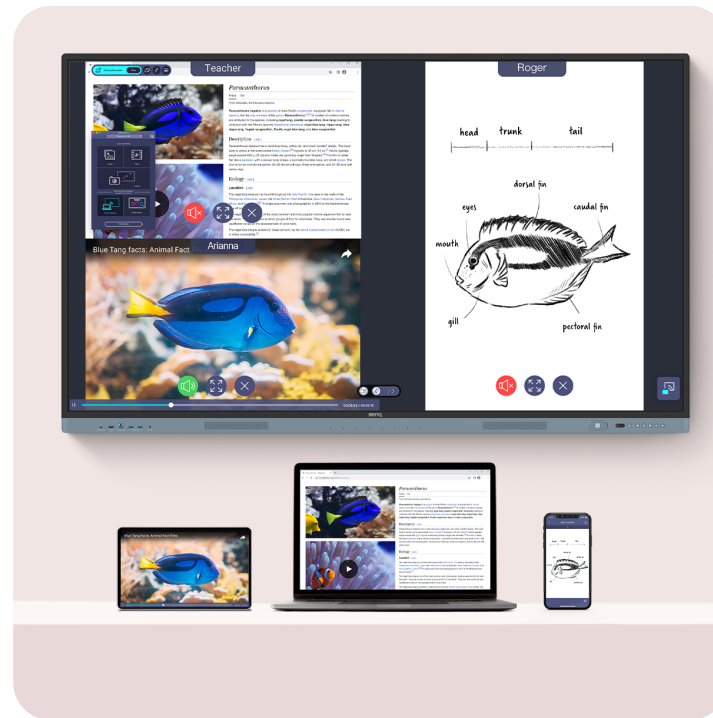

Simultaneously share screens



Cast your board to other screens

# An easier way to share

## Present diverse content

InstaShare 2 does more than screen sharing. You can also cast photos, videos, or your live camera feed for more dynamic presentations and discussions.

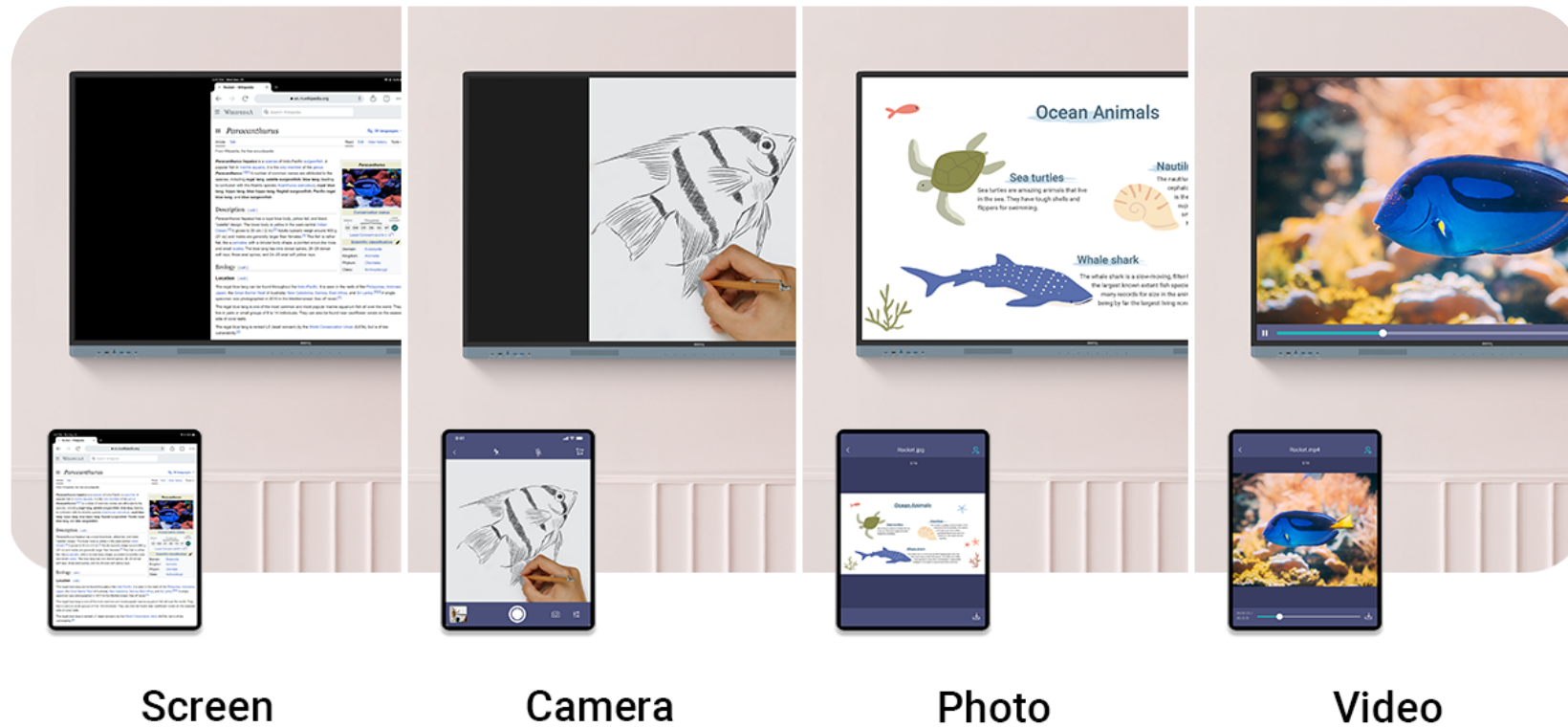

Screen

Camera

Photo

Video

# An easier way to share

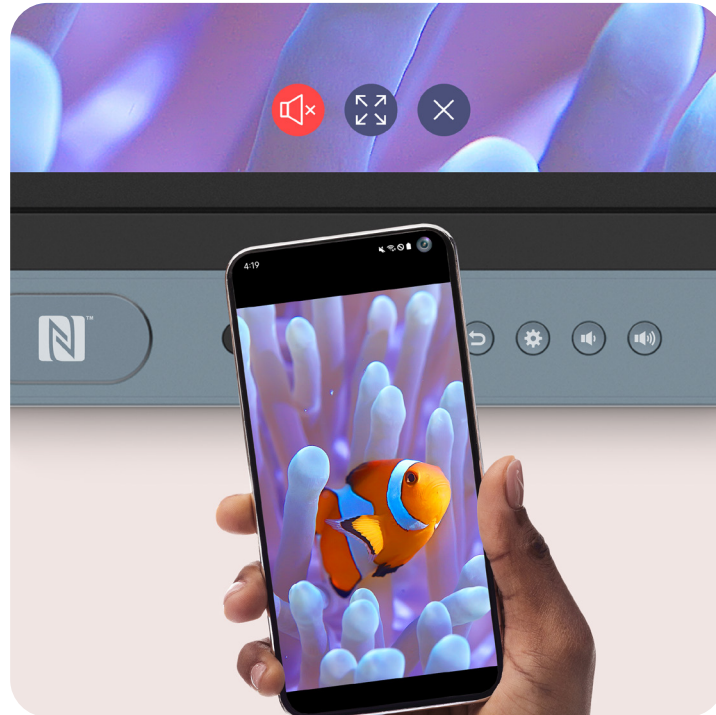

## Tap and share

Share pictures, videos, and other educational content directly from your Android phone by simply tapping it on the BenQ Board's NFC reader.

\*Available in Q1 2024.

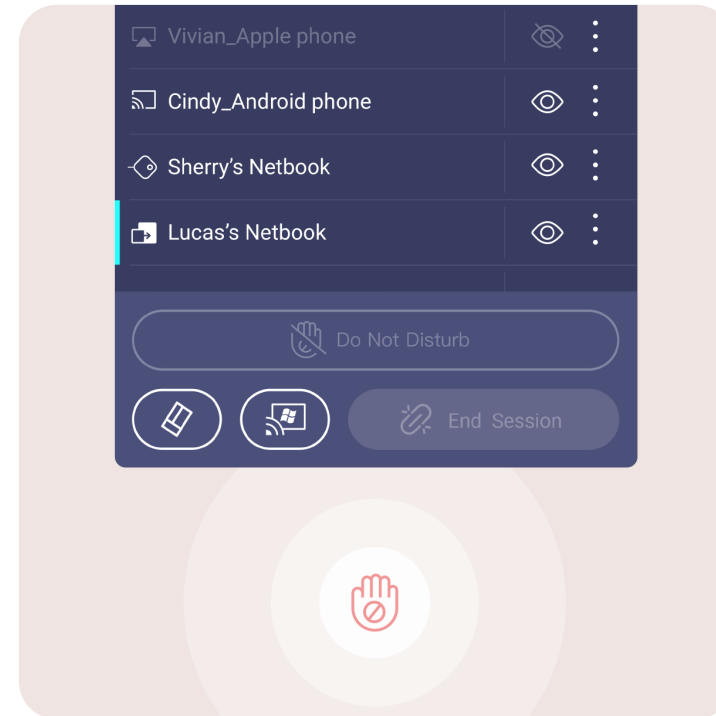

## Keep things in order

Even with multiple students sharing, it's easy to take control of the session on InstaShare 2. You can select which screens to show or hide, decline sharing requests, and even block inappropriate content with AI.



# Effortless management

BenQ's device and user management platforms allow IT staff to maintain their BenQ Boards without added complexity. We help significantly reduce their workload so they can focus on other tasks.





# Streamlined management

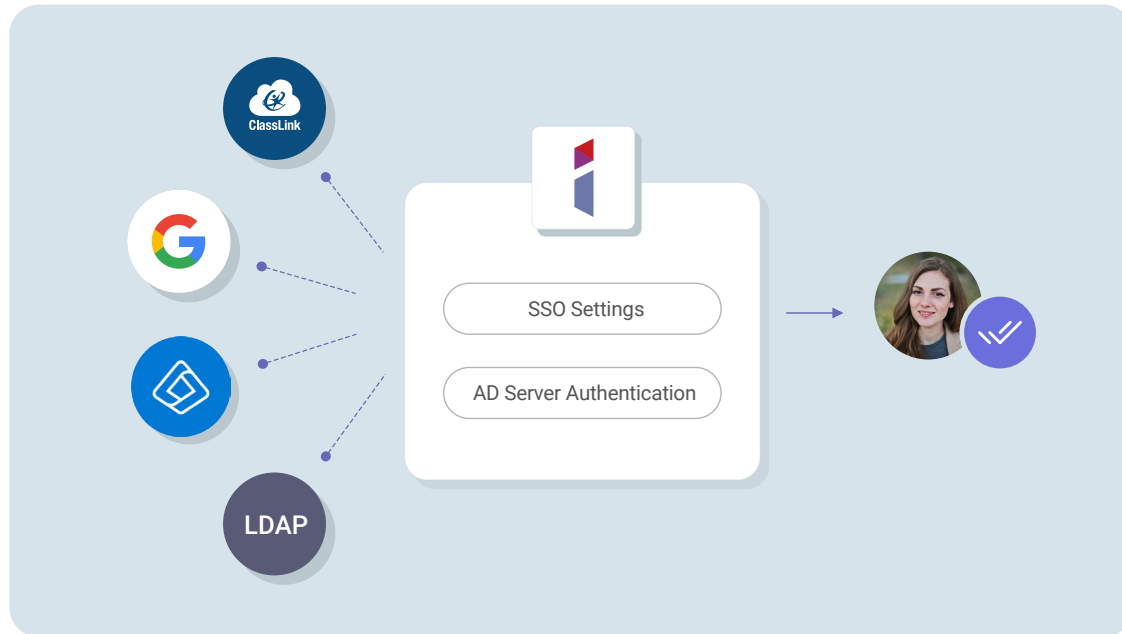

## Identity management syncing

Expedite user list management by syncing your BenQ Board user account list with your existing lists on Google Workspace, Microsoft Entra ID (formerly Azure Active Directory), ClassLink, LDAP, or other SAML-based identity provider.

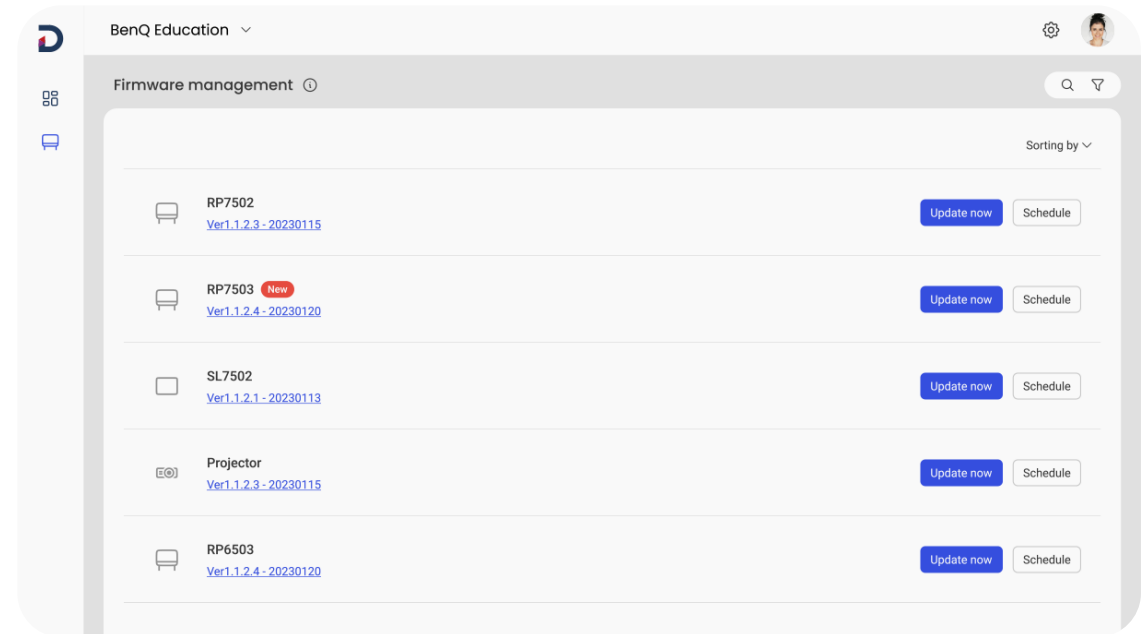

## Device and app management

Remotely monitor and manage all your BenQ devices. Install, update, and delete apps from a single dashboard that also lets you push firmware updates and set startup and shutdown times.

# Streamlined management

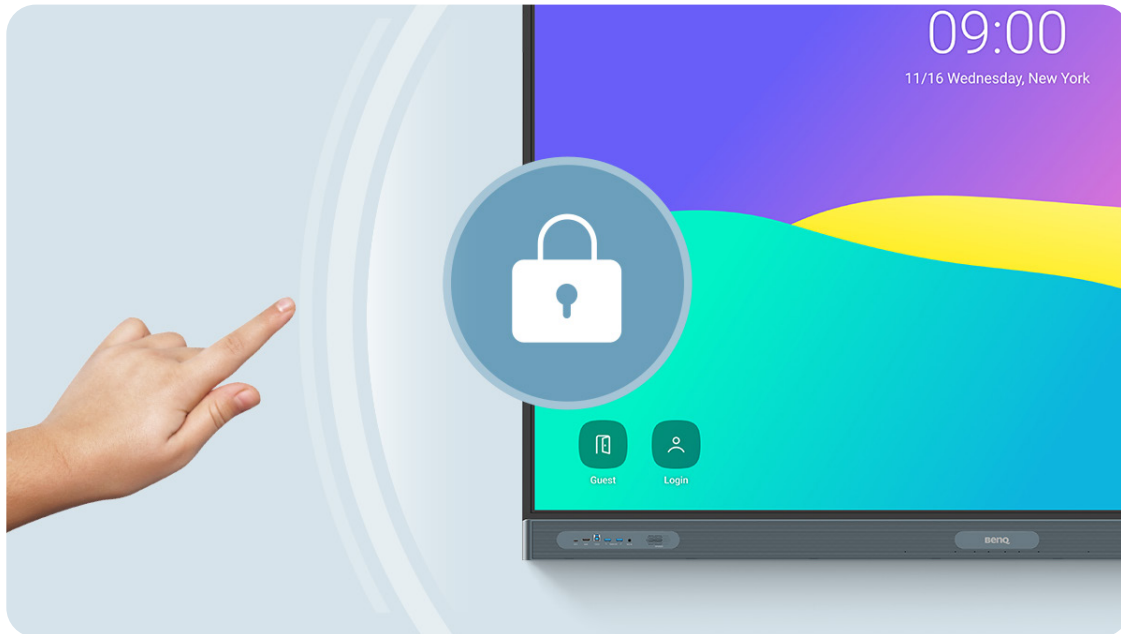

## More secure boards

The RM04 protects your school's data through secure login options, strict access controls, regular system updates, and app scanning via Google Play Protect.

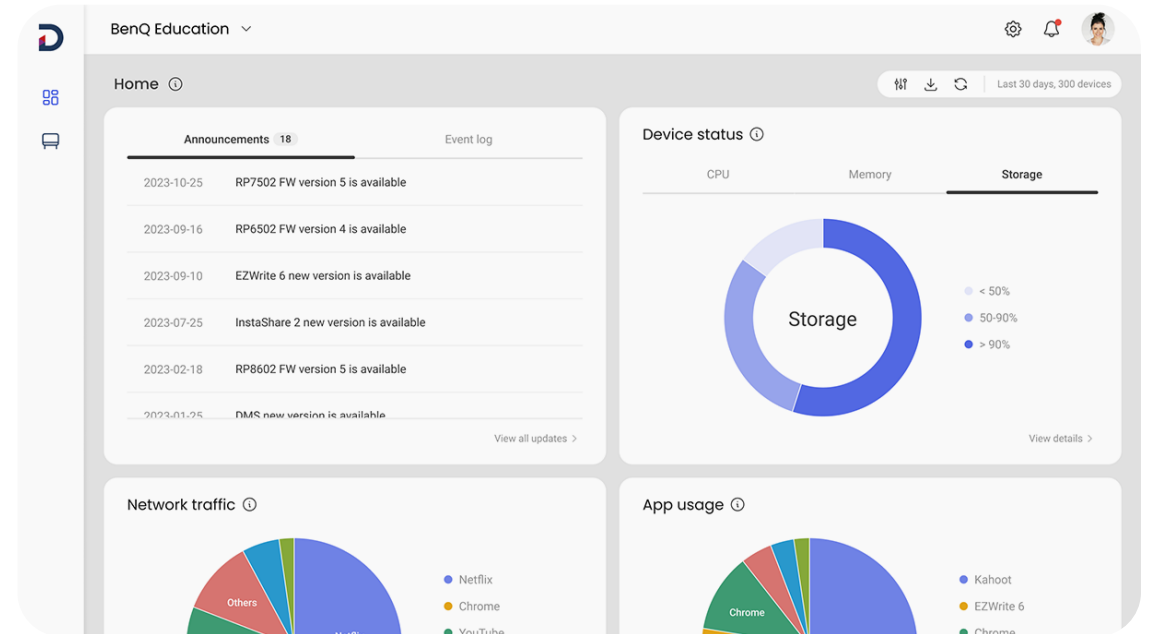

## Comprehensive analytics

Learn how your BenQ Boards are used and which apps are the most popular. Select specific devices and data points to generate more informative reports.

# Streamlined management

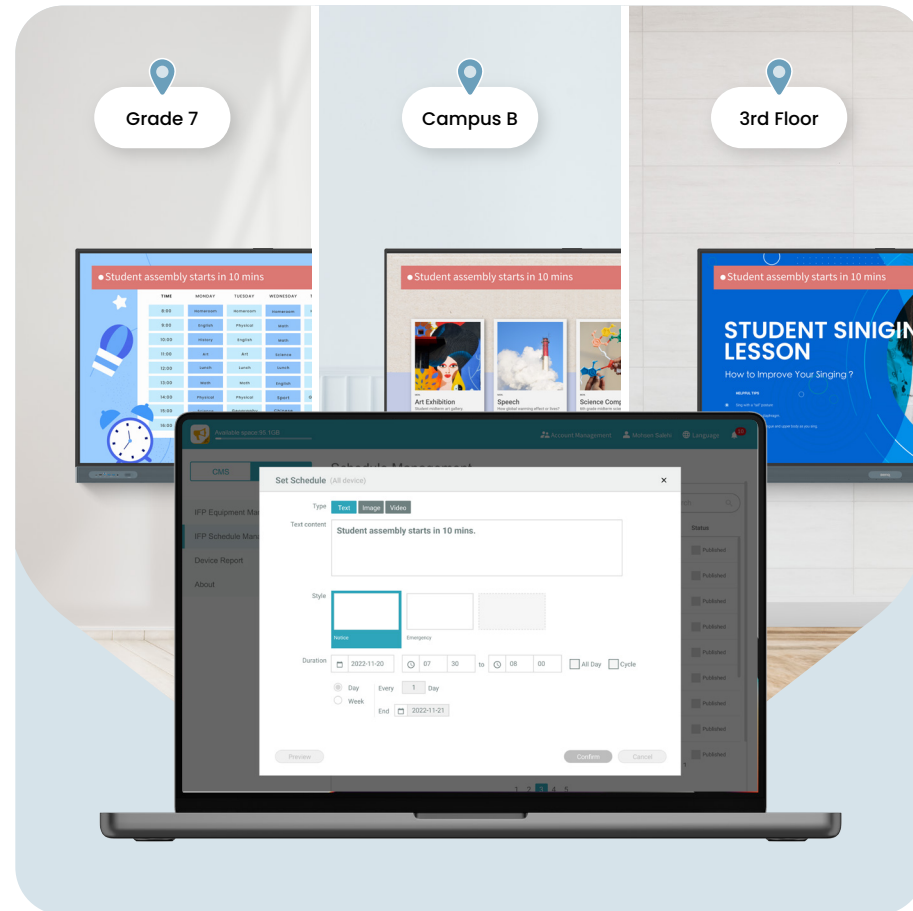

## School-wide communication

Deliver clear messages to multiple BenQ displays with X-Sign Broadcast. Keep everyone informed and up to date on events, safety protocols, and emergencies.



# Protect student health in classrooms

The BenQ Board Master is fitted with ClassroomCare® features that help schools make every classroom a healthier place for learning.





# Protect student health in classrooms

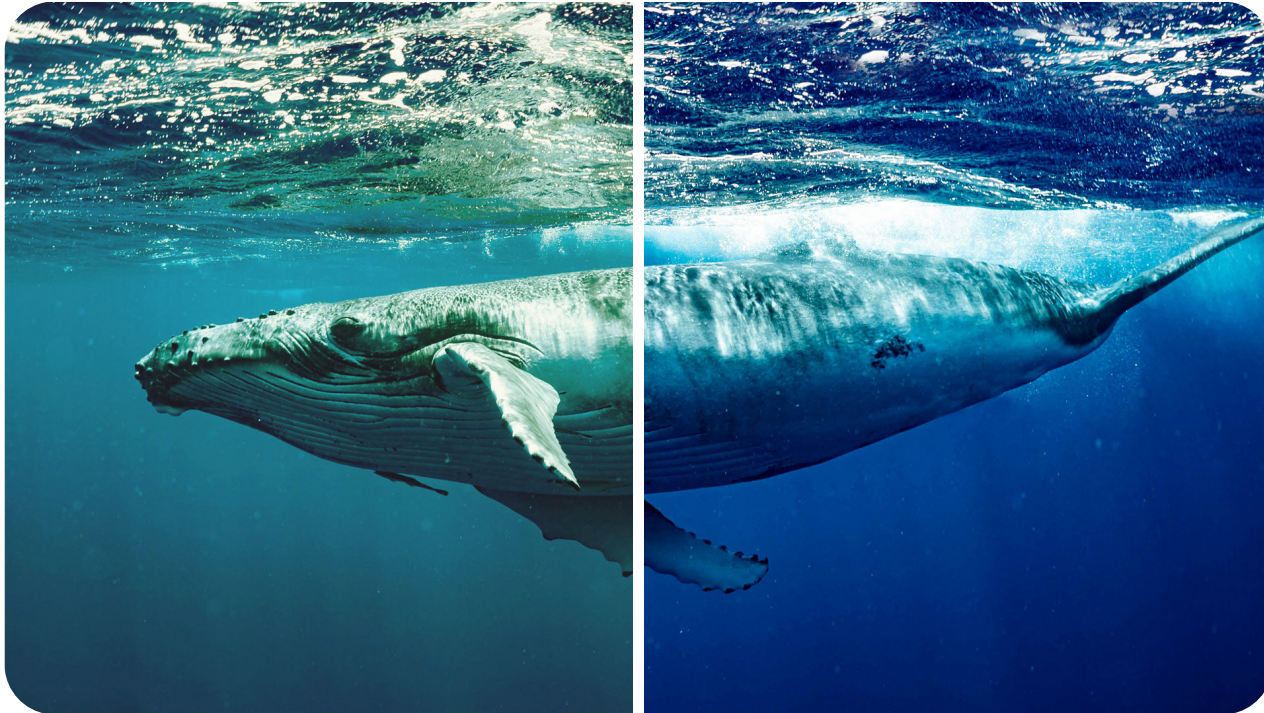

## Only the best for your eyes

The RM04 is Eyesafe® Certified 2.0, offering the highest level of protection available for the eyes. It reduces eye strain by effectively reducing high-energy blue light without altering the vivid colors displayed on screen.



Eyesafe®  
Certified 2.0



TÜV-certified



Flicker-free



Anti-glare

# Protect student health in classrooms



## Defend against germs

The RM04 helps reduce the transmission of germs in the classroom with its TÜV-certified antimicrobial screen and buttons that are 99.9% effective against common germs.



## Extended protection

Sharing tools in classrooms may lead to the spread of germs. That's why the RM04's remote control and pens are also germ-resistant.



## IP5X dust protection

Even in dust-prone classrooms, the RM04 ensures consistent operation. Its panel is compliant with IEC standard 60529.

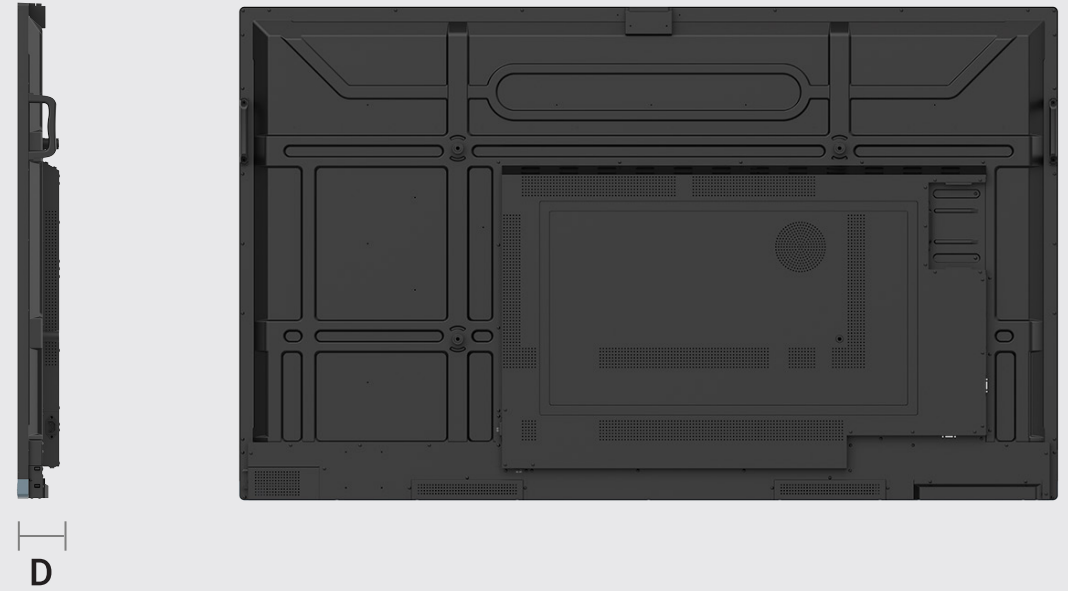

### Dimensions (W×H×D)

RM6504 | 1489.3 × 905.8 × 87.1 mm (58.6 × 35.7 × 3.4 in)

RM7504 | 1717.1 × 1036.8 × 87.1 mm (67.6 × 40.8 × 3.4 in)

RM8604 | 1962.4 × 1174.9 × 87.1 mm (77.3 × 46.3 × 3.4 in)

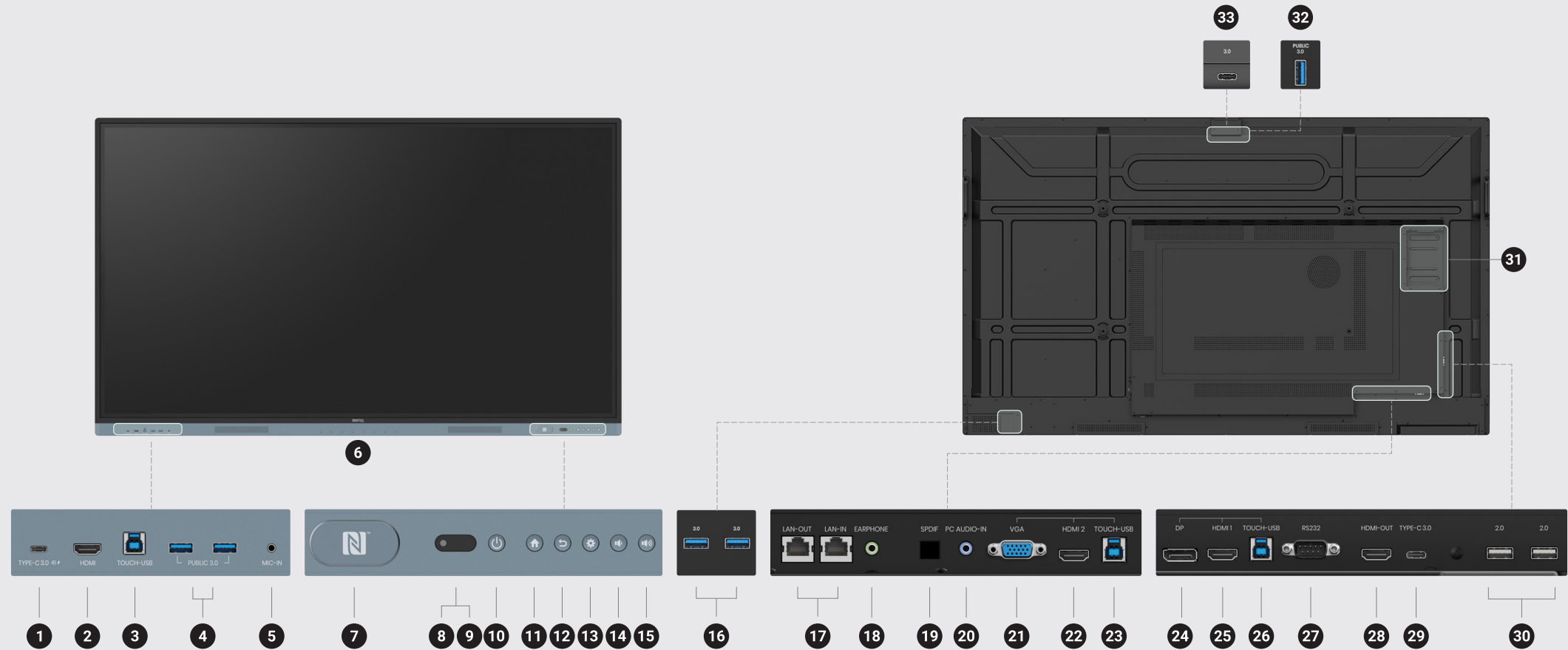

- |                   |                         |                 |                    |                    |                    |                    |
|-------------------|-------------------------|-----------------|--------------------|--------------------|--------------------|--------------------|
| 1. USB 3.0 Type-C | 6. 8-microphone array   | 11. Home        | 16. USB 3.0 Type-A | 21. VGA            | 26. Touch USB      | 31. OPS slot       |
| 2. HDMI in        | 7. NFC sensor           | 12. Back        | 17. Ethernet       | 22. HDMI in        | 27. RS-232         | 32. USB 3.0 Type-A |
| 3. Touch USB      | 8. Ambient light sensor | 13. Menu        | 18. Earphone jack  | 23. Touch USB      | 28. HDMI out       | 33. USB 3.0 Type-C |
| 4. USB 3.0 Type-A | 9. IR sensor            | 14. Volume down | 19. S/PDIF         | 24. DisplayPort in | 29. USB 3.0 Type-C |                    |
| 5. Microphone in  | 10. Power               | 15. Volume up   | 20. Audio in (VGA) | 25. HDMI in        | 30. USB 2.0 Type-A |                    |



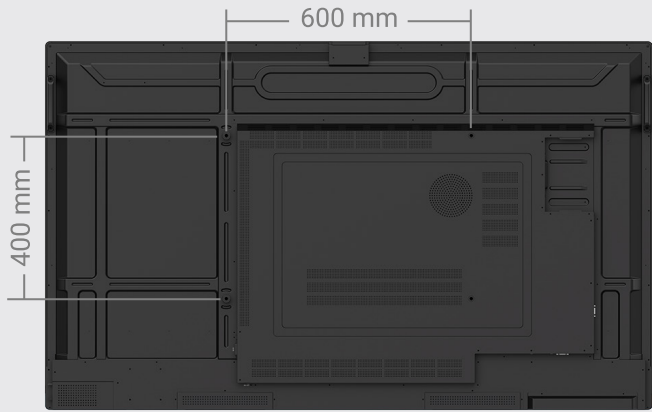

**RM6504**

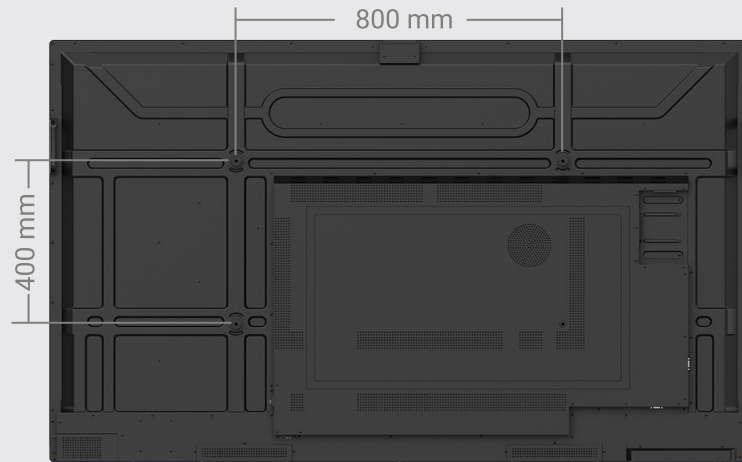

**RM7504**

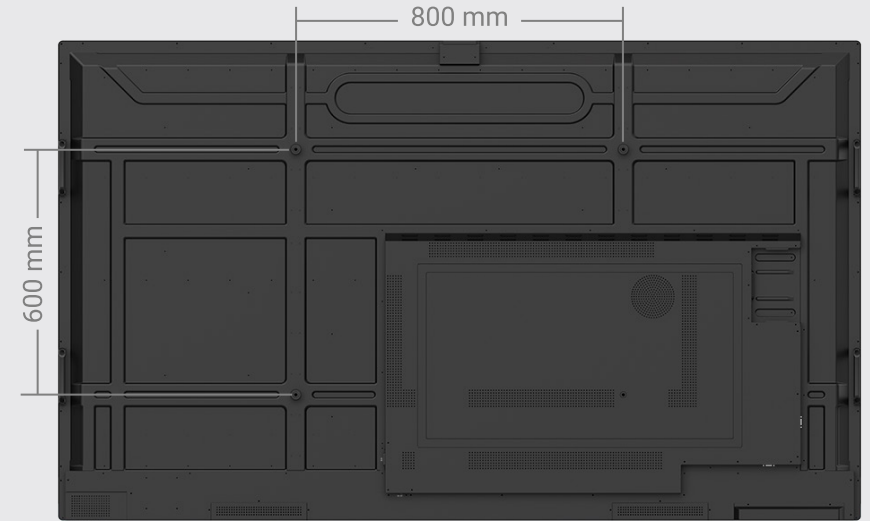

**RM8604**

Size	VESA specification	Screw type	Quantity
65"	600 × 400 mm	M8 × 25L	4
75"	800 × 400 mm	M8 × 25L	4
86"	800 × 600 mm	M8 × 25L	4

Model	RM6504	RM7504	RM8604
<b>Panel</b>			
Screen size	65"	75"	86"
Panel type	IPS	IPS	IPS
Resolution	UHD 3840 × 2160 pixels	UHD 3840 × 2160 pixels	UHD 3840 × 2160 pixels
Active area	1428.5 × 803.5 mm	1649.7 × 927.9 mm	1895.0 × 1066.0 mm
Aspect ratio	16:9	16:9	16:9
Panel brightness (typical)	450 nits	450 nits	450 nits
Contrast ratio (typical)	1200:1	1200:1	1200:1
Dynamic contrast ratio	50,000:1	50,000:1	50,000:1
Color depth	10-bit	10-bit	10-bit
Response time	8 ms	8 ms	8 ms
Color gamut	72% NTSC	72% NTSC	72% NTSC
Backlight life (typical)	50,000 hrs	50,000 hrs	50,000 hrs
Orientation	Landscape	Landscape	Landscape
<b>Glass</b>			
Hardness	9H tempered	9H tempered	9H tempered
Germ-resistant technology	Nano-ionic silver	Nano-ionic silver	Nano-ionic silver
Anti-glare	Yes	Yes	Yes
<b>Touch screen</b>			
Touch technology	High Precision IR	High Precision IR	High Precision IR
Touch points	up to 40	up to 40	up to 40
Touch response time	< 8 ms	< 8 ms	< 8 ms
<b>System</b>			
CPU	Arm Cortex-A73 × 4 + A53 × 4	Arm Cortex-A73 × 4 + A53 × 4	Arm Cortex-A73 × 4 + A53 × 4
GPU	Arm Mali-G52 MP8	Arm Mali-G52 MP8	Arm Mali-G52 MP8
Memory   Storage	8GB   64GB, 8GB   128GB	8GB   64GB, 8GB   128GB	8GB   64GB, 8GB   128GB
Operating system	Android 13 (EDLA)	Android 13 (EDLA)	Android 13 (EDLA)

Connectivity			
USB-C	1 × 3.0 (PD 65 W), 2 × 3.0	1 × 3.0 (PD 65 W), 2 × 3.0	1 × 3.0 (PD 65 W), 2 × 3.0
USB Type-B (for touch)	3 × 3.0	3 × 3.0	3 × 3.0
USB Type-A	5 × 3.0, 2 × 2.0	5 × 3.0, 2 × 2.0	5 × 3.0, 2 × 2.0
HDMI (in   out)	3 × HDMI 2.0   1 × HDMI 2.0	3 × HDMI 2.0   1 × HDMI 2.0	3 × HDMI 2.0   1 × HDMI 2.0
DisplayPort in	1 × 1.2a	1 × 1.2a	1 × 1.2a
VGA in	1	1	1
Audio in	1 × 3.5 mm microphone jack 1 × 3.5 mm audio jack (VGA)	1 × 3.5 mm microphone jack 1 × 3.5 mm audio jack (VGA)	1 × 3.5 mm microphone jack 1 × 3.5 mm audio jack (VGA)
Audio out	1 × 3.5 mm earphone jack	1 × 3.5 mm earphone jack	1 × 3.5 mm earphone jack
S/PDIF out	1 (optical)	1 (optical)	1 (optical)
RS-232	1	1	1
OPS slot (for slot-in PC)	1	1	1
Ethernet	Gigabit	Gigabit	Gigabit
Wi-Fi	Wi-Fi 6 (optional)	Wi-Fi 6 (optional)	Wi-Fi 6 (optional)
Bluetooth®	Bluetooth 5.2 (optional)	Bluetooth 5.2 (optional)	Bluetooth 5.2 (optional)
Built-in peripherals			
NFC sensor	Yes	Yes	Yes
Ambient light sensor	Yes	Yes	Yes
IR sensor	Yes	Yes	Yes
Microphone	8-microphone array (range: up to 8 m   26ft)	8-microphone array (range: up to 8 m   26ft)	8-microphone array (range: up to 8 m   26ft)
Speaker	2 × 20 W (max)	2 × 20 W (max)	2 × 20 W (max)
Power			
ENERGY STAR®	Yes	Yes	Yes
Power	AC 100-240V 50/60Hz	AC 100-240V 50/60Hz	AC 100-240V 50/60Hz
Standby power consumption	<0.5 W	<0.5 W	<0.5 W
Typical power consumption	106.1 W	124.7 W	168.9 W
Physical			
Dimensions (W × H × D)	1489.3 × 905.8 × 87.1 mm (58.6 × 36.9 × 4.6 in)	1717.1 × 1036.8 × 87.1 mm (67.6 × 40.8 × 3.4 in)	1962.4 × 1174.9 × 87.1 mm (77.3 × 46.3 × 3.4 in)
Shipping dimensions (W × H × D)	1640 × 1010 × 185 mm (64.6 × 39.8 × 7.3 in)	1860 × 1125 × 185 mm (73.2 × 44.3 × 7.3 in)	2095 × 1265 × 185 mm (82.5 × 49.8 × 7.3 in)
Weight (product   shipping)	37.8 kg   51.5 kg (83.3 lbs   113.5 lbs)	51.5 kg   67.6 kg (113.5 lbs   149 lbs)	65.2 kg   82.9 kg (143.7 lbs   182.8 lbs)
Mount (screws)	VESA 600 × 400 mm (4 × M8 × 25L)	VESA 800 × 400 mm (4 × M8 × 25L)	VESA 800 × 600 mm (4 × M8 × 25L)

Environment			
Operating temperature	0°C ~ 40°C   32°F ~ 104°F	0°C ~ 40°C   32°F ~ 104°F	0°C ~ 40°C   32°F ~ 104°F
Storage temperature	-10°C ~ 60°C   14°F ~ 140°F	-10°C ~ 60°C   14°F ~ 140°F	-10°C ~ 60°C   14°F ~ 140°F
Storage humidity	10% ~ 80% RH non-condensing	10% ~ 80% RH non-condensing	10% ~ 80% RH non-condensing
Operating humidity	20% ~ 80% RH non-condensing	20% ~ 80% RH non-condensing	20% ~ 80% RH non-condensing
Software			
Whiteboarding	EZWrite 6.0	EZWrite 6.0	EZWrite 6.0
Wireless screen sharing	InstaShare 2	InstaShare 2	InstaShare 2
Account management	AMS	AMS	AMS
Device management	DMS	DMS	DMS
Quick access tool	Floating Tool	Floating Tool	Floating Tool
Broadcast system	X-Sign Broadcast	X-Sign Broadcast	X-Sign Broadcast
Accessories			
Cables	1 × VGA (3 m   9.8 ft), 1 × HDMI (3 m   9.8ft), 1 × USB Type-B for touch (3 m   9.8ft), 1 × USB-C (1.5 m   4.9 ft)	1 × VGA (3 m   9.8 ft), 1 × HDMI (3 m   9.8ft), 1 × USB Type-B for touch (3 m   9.8ft), 1 × USB-C (1.5 m   4.9 ft)	1 × VGA (3 m   9.8 ft), 1 × HDMI (3 m   9.8ft), 1 × USB Type-B for touch (3 m   9.8ft), 1 × USB-C (1.5 m   4.9 ft)
Wall mount	1	1	1
Pen	2	2	2
Remote control	1	1	1





Dealer's Stamp

**BenQ**

©2023 BenQ Corp. Specification may vary by region, please visit your local stores for details. Actual product's features and specifications are subject to change without notice.  
This material may include corporate names and trademarks of third parties which are the properties of the third parties respectively.  
Doc.: PDP\_RM6504/RM7504/RM8604\_IFP\_EN\_202311